

# SPECIFICATIONS

<b>Customer</b>	
<b>Product Name</b>	<b>Multi-layer Chip Ferrite Bead</b>
<b>Sunlord Part Number</b>	<b>GZ Series</b>
<b>Customer Part Number</b>	

New Released,  Revised]

**SPEC No.:** GZ110000

Rev.	Effective Date	Changed Contents	Change Reasons	Approved By
01		New release	/	Hai Guo

**【This SPEC is total 16 pages including specifications and appendix.】**

**【ROHS Compliant Parts】**

Approved By	Checked By	Issued By

## Shenzhen Sunlord Electronics Co., Ltd.

Address: Sunlord Industrial Park, Dafuyuan Industrial Zone, Guanlan, Shenzhen, China 518110  
 Tel: 0086-755-29832660 Fax: 0086-755-82269029 E-Mail: sunlord@sunlordinc.com

**【For Customer approval Only】**

Date: \_\_\_\_\_

Qualification Status:  Full  Restricted  Rejected

Approved By	Verified By	Re-checked By	Checked By

Comments:

\_\_\_\_\_

1. Scope

This specification applies to GZ Series of multi-layer ferrite chip bead.

2. Product Description and Identification (Part Number)

- 1) Description:  
GZ Series of multi-layer ferrite chip bead.
- 2) Product Identification (Part Number)

GZ    ※※※※    ○    XXX    ◎    F  
 ①            ②            ③            ④            ⑤            ⑥

①	Type
GZ	For General Use

③	Material Code
D, U, E	

⑤	Packing
T	Tape Carrier Package

⑥	HSF Products
Hazardous Substance Free Products	

②	External Dimensions (L X W)[mm]	
0603 [0201]	0.6 X 0.3	
1005 [0402]	1.0 X 0.5	
1608 [0603]	1.6 X 0.8	
2012 [0805]	2.0 X 1.25	
3216 [1206]	3.2 X 1.6	

④	Nominal Impedance	
Example	Nominal Value	
300	30Ω	
121	120Ω	

3. Electrical Characteristics

Please refer to **Appendix A** (Page 7~16).

- 1) Operating and storage temperature range (individual chip without packing): -55°C ~ +125°C.
- 2) Storage temperature range (packaging conditions):-10°C~+40°C and RH 70% (Max.)

4. Shape and Dimensions

- 1) Dimensions and recommended PCB pattern for reflow soldering: See **Fig.4-1**, **Fig.4-2** and **Table 4-1**.
- 2) Structure: See **Fig. 4-3** and **Fig. 4-4**.

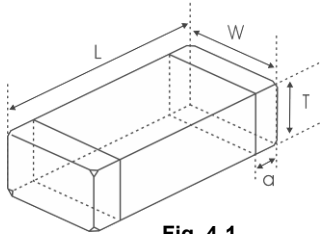

Fig. 4-1

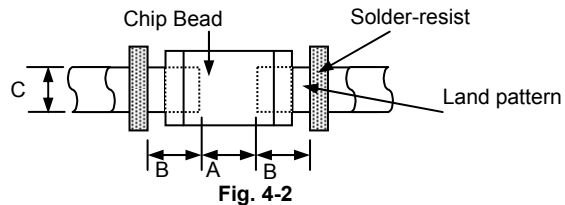

Fig. 4-2

[Table 4-1]

Unit: mm [inch]

Type	L	W	T	a	A	B	C
0603 [0201]	0.6±0.05 [.024±0.002]	0.3±0.05 [.012±0.002]	0.3±0.05 [.012±0.002]	0.15±0.05 [.006±0.002]	0.2~0.3	0.2~0.3	0.3~0.35
1005 [0402]	1.0±0.15 [0.039±0.006]	0.5±0.15 [0.020±0.006]	0.5±0.15 [0.020±0.006]	0.25±0.1 [0.010±0.004]	0.45~0.55	0.40~0.50	0.45~0.55
1608 [0603]	1.6±0.15 [0.063±0.006]	0.8±0.15 [0.031±0.006]	0.8±0.15 [0.031±0.006]	0.3±0.2 [0.012±0.008]	0.60~0.80	0.60~0.80	0.60~0.80
2012 [0805]	2.0 (+0.3, -0.1) [0.079(+0.012,-0.004)]	1.25±0.2 [0.049±0.008]	0.85±0.2 [0.033±0.008]	0.5±0.3 [0.020±0.012]	0.80~1.20	0.80~1.20	0.90~1.60
3216 [1206]	3.2±0.2 [0.126±0.008]	1.6±0.2 [0.063±0.008]	0.85±0.2 [0.033±0.008]	0.5±0.3 [0.020±0.012]	1.80~2.50	1.00~1.50	1.20~2.00

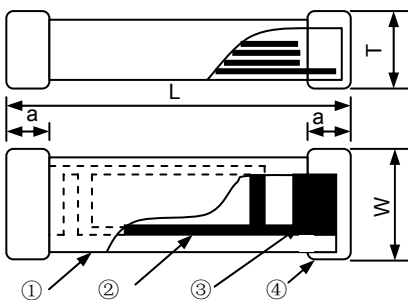

Fig. 4-3

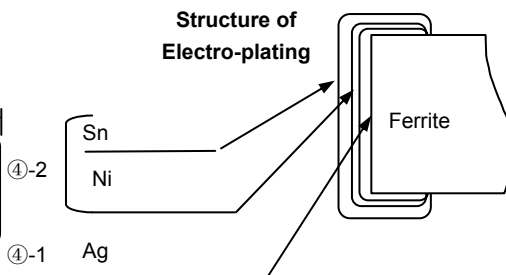

Fig. 4-4

- ① Ferrite for Bead Series
- ② Internal electrode (Ag)
- ③ Pull out electrode (Ag)
- ④-1 Terminal electrode: Inside (Ag)
- ④-2 Outside (Electro-plating Ni-Sn)

3) Material Information: See Table 4-2.

[Table 4-2]

Code	Part Name	Material Name
①	Ferrite Body	Ferrite Powder
②	Inner Coils	Silver Paste
③	Pull-out Electrode (Ag)	Silver Paste
④-1	Terminal Electrode: Inside Ag	Termination Silver Composition
④-2	Electro-Plating: Ni/Sn plating	Plating Chemicals

5. Test and Measurement Procedures

5.1 Test Conditions

5.1.1 Unless otherwise specified, the standard atmospheric conditions for measurement/test as:

- a. Ambient Temperature: 20±15°C
- b. Relative Humidity: 65±20%
- c. Air Pressure: 86kPa to 106kPa

5.1.2 If any doubt on the results, measurements/tests should be made within the following limits:

- a. Ambient Temperature: 20±2°C
- b. Relative Humidity: 65±5%
- c. Air Pressure: 86kPa to 106kPa

5.2 Visual Examination

- a. Inspection Equipment: 20× magnifier

5.3 Electrical Test

5.3.1 DC Resistance (DCR)

- a. Refer to Appendix A.
- b. Test equipment (Analyzer): High Accuracy Milliohmmeter-HP4338B or equivalent.

5.3.2 Impedance (Z)

- a. Refer to Appendix A.
- b. Test equipment: High Accuracy RF Impedance /Material Analyzer-E4991A or equivalent.  
Test fixture: HP16197A for 0603, HP16192A for 1005/1608/2012/3216.  
Test signal: -20dBm or 50mV
- c. Test frequency refers to Appendix A.

5.3.3 Rated Current

- a. Refer to Appendix A.
- b. Test equipment (see Fig.5.3.3-1): Electric Power, Electric current meter, Thermometer.
- c. Measurement method (see Fig. 5.3.3-1):
  1. Set test current to be 0 mA.
  2. Measure initial temperature of chip surface.
  3. Gradually increase voltage and measure chip temperature for corresponding current.
- d. Definition of Rated Current (Ir): Ir is direct electric current as chip surface temperature rose just 20°C against chip initial surface temperature (Ta) (see Fig. 5.3.3-2)

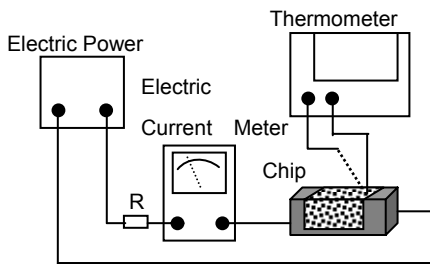

Fig. 5.3.3-1

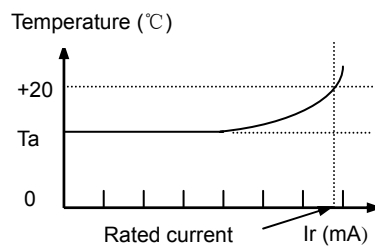
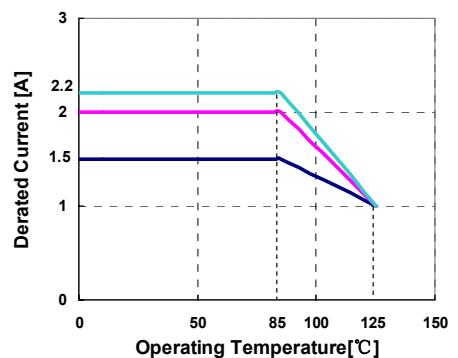
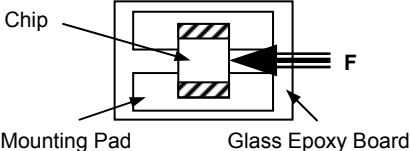
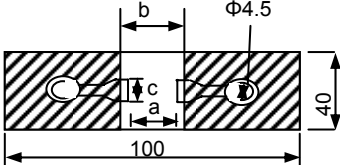
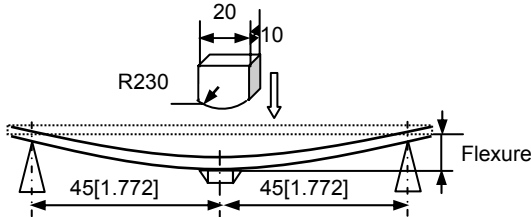
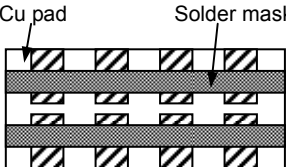

Fig. 5.3.3-2

- e. When operating temperatures exceeding +85°C, derating of current is necessary for chip ferrite beads for which rated current is 1000mA over. Please apply the derating curve shown in chart according to the operating temperature.



5.4 Reliability Test

Items	Requirements	Test Methods and Remarks																								
5.4.1 Terminal Strength	No removal or split of the termination or other defects shall occur.  Fig.5.4.1-1	<ol style="list-style-type: none"> <li>① Solder the bead to the testing jig (glass epoxy board shown in Fig. 5.4.1-1) using eutectic solder. Then apply a force in the direction of the arrow.</li> <li>② 2N force for 0603 series, 5N force for 1005 and 1608 series 10N force for 2012 and 3216 series.</li> <li>③ Keep time: 10±1s.</li> <li>④ Speed: 1.0mm/s.</li> </ol>																								
5.4.2 Resistance to Flexure	No visible mechanical damage. Unit: mm [inch] <table border="1" data-bbox="325 533 756 792"> <thead> <tr> <th>Type</th> <th>a</th> <th>b</th> <th>c</th> </tr> </thead> <tbody> <tr> <td>0603[0201]</td> <td>0.25</td> <td>0.8</td> <td>0.3</td> </tr> <tr> <td>1005[0402]</td> <td>0.4</td> <td>1.5</td> <td>0.5</td> </tr> <tr> <td>1608[0603]</td> <td>1.0</td> <td>3.0</td> <td>1.2</td> </tr> <tr> <td>2012[0805]</td> <td>1.2</td> <td>4.0</td> <td>1.65</td> </tr> <tr> <td>3216[1206]</td> <td>2.2</td> <td>5.0</td> <td>2.0</td> </tr> </tbody> </table>  Fig. 5.4.2-1	Type	a	b	c	0603[0201]	0.25	0.8	0.3	1005[0402]	0.4	1.5	0.5	1608[0603]	1.0	3.0	1.2	2012[0805]	1.2	4.0	1.65	3216[1206]	2.2	5.0	2.0	<ol style="list-style-type: none"> <li>① Solder the bead to the test jig (glass epoxy board shown in Fig. 5.4.2-1) Using a eutectic solder. Then apply a force in the direction shown Fig. 5.4.2-2.</li> <li>② Flexure: 2mm.</li> <li>③ Pressurizing Speed: 0.5mm/sec.</li> <li>④ Keep time: 30 sec.</li> </ol>  Fig. 5.4.2-2
Type	a	b	c																							
0603[0201]	0.25	0.8	0.3																							
1005[0402]	0.4	1.5	0.5																							
1608[0603]	1.0	3.0	1.2																							
2012[0805]	1.2	4.0	1.65																							
3216[1206]	2.2	5.0	2.0																							
5.4.3 Vibration	<ol style="list-style-type: none"> <li>① No visible mechanical damage.</li> <li>② Impedance change: within ±20%</li> </ol>  Glass Epoxy Board Fig. 5.4.3-1	<ol style="list-style-type: none"> <li>① Solder the bead to the testing jig (glass epoxy board shown in Fig. 5.4.3-1) using eutectic solder.</li> <li>② The bead shall be subjected to a simple harmonic motion having total amplitude of 1.5 mm, the frequency being varied uniformly between the approximate limits of 10 and 55 Hz.</li> <li>③ The frequency range from 10 to 55 Hz and return to 10 Hz shall be traversed in approximately 1 minute. This motion shall be applied for a period of 2 hours in each 3 mutually perpendicular directions (total of 6 hours).</li> </ol>																								
5.4.4 Dropping	<ol style="list-style-type: none"> <li>① No visible mechanical damage.</li> <li>② Impedance change: within ±20%.</li> </ol>	Drop chip bead 10 times on a concrete floor from a height of 100 cm.																								
5.4.5 Temperature	Impedance change should be within ±20% of initial value measuring at 20°C.	Temperature range: -55°C ~ 125°C. Reference temperature: +20°C.																								
5.4.6 Solderability	<ol style="list-style-type: none"> <li>① No visible mechanical damage.</li> <li>② Wetting shall exceed 75% coverage for 0603 series; exceed 95% for others</li> </ol>	<ol style="list-style-type: none"> <li>① Solder temperature: 240±2°C</li> <li>② Duration: 3 sec.</li> <li>③ Solder: Sn/3.0Ag/0.5Cu.</li> <li>④ Flux: 25% Resin and 75% ethanol in weight.</li> </ol>																								
5.4.7 Resistance to Soldering Heat	<ol style="list-style-type: none"> <li>① No visible mechanical damage.</li> <li>② Wetting shall exceed 75% coverage for 0603 series; exceed 95% for others</li> <li>③ Impedance change: within ±20%.</li> </ol>	<ol style="list-style-type: none"> <li>① Solder temperature :260±3°C</li> <li>② Duration: 5 sec.</li> <li>③ Solder: Sn/3.0Ag/0.5Cu.</li> <li>④ Flux: 25% Resin and 75% ethanol in weight.</li> <li>⑤ The chip shall be stabilized at normal condition for 1~2 hours before measuring.</li> </ol>																								

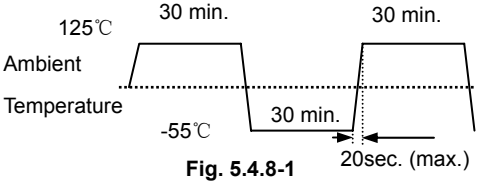
<p>5.4.8 Thermal Shock</p>	<p>① No mechanical damage. ② Impedance change: Within <math>\pm 20\%</math>.</p>  <p><b>Fig. 5.4.8-1</b></p>	<p>① Temperature, Time: (See <b>Fig.5.4.8-1</b>) -55°C for 30±3 min→125°C for 30±3min. ② Transforming interval: Max. 20 sec. ③ Tested cycle: 100 cycles. ④ The chip shall be stabilized at normal condition for 1~2 hours before measuring.</p>
<p>5.4.9 Resistance to Low Temperature</p>	<p>① No mechanical damage. ② Impedance change: within <math>\pm 20\%</math>.</p>	<p>① Temperature: -55±2°C ② Duration: 1000<sup>+24</sup> hours. ③ The chip shall be stabilized at normal condition for 1~2 hours before measuring.</p>
<p>5.4.10 Resistance to High Temperature</p>	<p>① No mechanical damage. ② Impedance change: within <math>\pm 20\%</math>.</p>	<p>① Temperature: 125±2°C ② Duration: 1000<sup>+24</sup> hours. ③ The chip shall be stabilized at normal condition for 1~2 hours before measuring.</p>
<p>5.4.11 Damp Heat (Steady States)</p>	<p>① No mechanical damage. ② Impedance change: Within <math>\pm 20\%</math>.</p>	<p>① Temperature: 60±2°C ② Humidity: 90% to 95% RH. ③ Duration: 1000<sup>+24</sup> hours. ④ The chip shall be stabilized at normal condition for 1~2 hours before measuring.</p>
<p>5.4.12 Loading Under Damp Heat</p>	<p>① No visible mechanical damage. ② Impedance change: within <math>\pm 20\%</math>.</p>	<p>① Temperature: 60±2°C ② Humidity: 90% to 95% RH. ③ Duration: 1000<sup>+24</sup> hours. ④ Applied current: Rated current. ⑤ The chip shall be stabilized at normal condition for 1~2 hours before measuring.</p>
<p>5.4.13 Loading at High Temperature (Life Test)</p>	<p>① No visible mechanical damage. ② Impedance change: within <math>\pm 20\%</math>.</p>	<p>① Temperature: 125±2°C ② Duration: 1000<sup>+24</sup> hours. ③ Applied current: Rated current. ④ The chip shall be stabilized at normal condition for 1~2 hours before measuring.</p>

6. Packaging, Storage

6.1 Packaging

Tape Carrier Packaging:

Packaging code: T

- a. Tape carrier packaging are specified in attached figure **Fig.6.1-1~3**
- b. Tape carrier packaging quantity please see the following table:

Type	0603[0201]	1005[0402]	1608[0603]	2012[0805]	3216[1206]
T(mm)	0.3±0.15	0.5±0.15	0.8±0.15	0.85±0.2	0.85±0.2
Tape	Paper Tape	Paper Tape	Paper Tape	Paper Tape	Paper Tape
Quantity	15K	10K	4K	4K	3K

(1) Taping Drawings (Unit: mm)

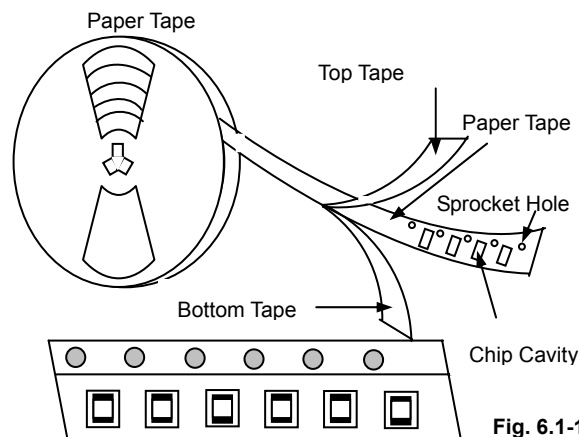

**Remark:** The sprocket holes are to the right as the tape is pulled toward the user.

(2) Taping Dimensions (Unit: mm)

Sprocket Hole  $\Phi 1.5 (+0.1, 0)$

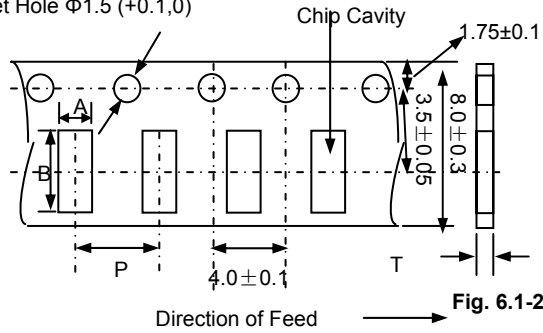

Paper Tape

Type	A	B	P	T max
0603[0201]	0.40±0.1	0.70±0.1	2.0±0.1	0.55
1005[0402]	0.65±0.1	1.15±0.1	2.0±0.05	0.8
1608[0603]	1.0±0.2	1.8±0.2	4.0±0.1	1.1
2012[0805]	1.5±0.2	2.3±0.2	4.0±0.1	1.1
3216[1206]	1.9±0.2	3.5±0.2	4.0±0.1	1.1

(3) Reel Dimensions (Unit: mm)

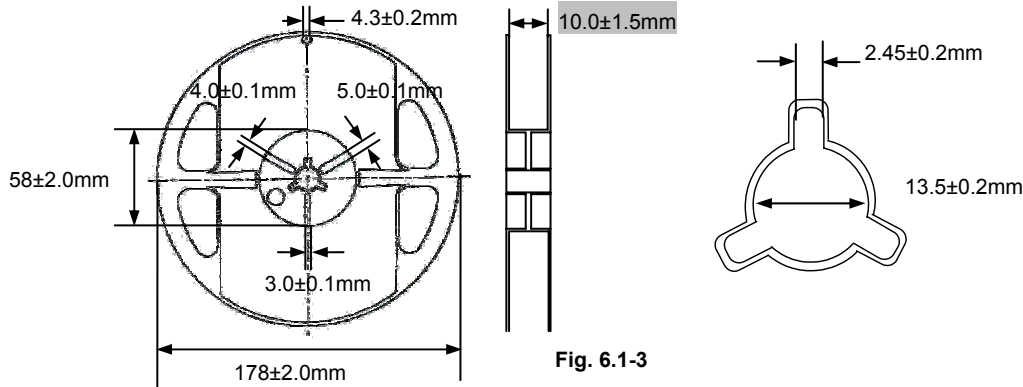

6.2 Storage

- a. The solderability of the external electrode may be deteriorated if packages are stored where they are exposed to high humidity. Package must be stored at 40°C or less and 70% RH or less.
- b. The solderability of the external electrode may be deteriorated if packages are stored where they are exposed to dust or harmful gas (e.g. HCl, sulfurous gas of H<sub>2</sub>S).
- c. Packaging material may be deformed if package are stored where they are exposed to heat of direct sunlight.
- d. Solderability specified in **Clause 5.4.6** shall be guaranteed for 12 months from the date of delivery on condition that they are stored at the environment specified in **Clause 3**. For those parts, which passed more than 12 months shall be checked solder-ability before use.

7. Recommended Soldering Technologies

7.1 Re-flowing Profile:

- △ Preheat condition: 150 ~200°C/60~120sec.
- △ Allowed time above 217°C: 60~90sec.
- △ Max temp: 260°C
- △ Max time at max temp: 10sec.
- △ Solder paste: Sn/3.0Ag/0.5Cu
- △ Allowed Reflow time: 2x max

[Note: The reflow profile in the above table is only for qualification and is not meant to specify board assembly profiles. Actual board assembly profiles must be based on the customer's specific board design, solder paste and process, and should not exceed the parameters as the Reflow profile shows.]

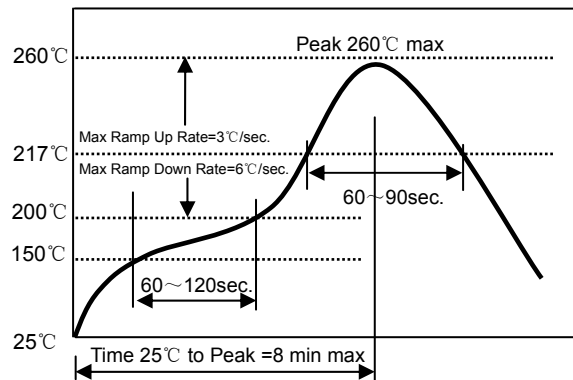

7.2 Iron Soldering Profile.

- △ Iron soldering power: Max. 30W
- △ Pre-heating: 150°C/60sec.
- △ Soldering Tip temperature: 350°C Max.
- △ Soldering time: 3sec. Max.
- △ Solder paste: Sn/3.0Ag/0.5Cu
- △ Max.1 times for iron soldering

[Note: Take care not to apply the tip of the soldering iron to the terminal electrodes.]

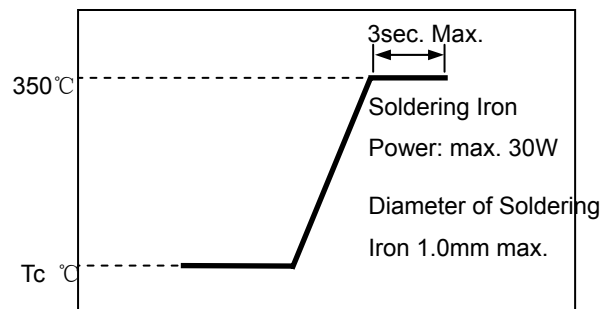

## 8. Supplier Information

- a) Supplier:  
**Shenzhen Sunlord Electronics Co., Ltd.**
- b) Manufacture:  
**Shenzhen Sunlord Electronics Co., Ltd.**
- c) Manufacturing Address:  
**Sunlord Industrial Park, Dafuyuan Industrial Zone, Guanlan, Shenzhen, China 518110**

## Appendix A: Electrical Characteristics

## I. GZ0603 Series of Beads

Part Number	Impedance ( $\Omega$ )	Z Test Freq. (MHz)	DCR ( $\Omega$ ) Max.	I <sub>r</sub> (mA) Max.	Thickness (mm) [inch]
GZ0603D600TF	60±25%	100	0.40	200	0.3±0.05 [.012±.002]
GZ0603D800TF	80±25%	100	0.60	200	
GZ0603D121TF	120±25%	100	0.80	200	
GZ0603D241TF	240±25%	100	1.00	200	
GZ0603D471TF	470±25%	100	1.40	200	
GZ0603D601TF	600±25%	100	1.70	200	

## I. GZ1005 Series of Beads

Part Number	Impedance ( $\Omega$ )	Z Test Freq. (MHz)	DCR ( $\Omega$ ) Max.	I <sub>r</sub> (mA) Max.	Thickness (mm) [inch]
GZ1005D100TF	0~15	100	0.05	500	0.5±0.15 [.020±.006]
GZ1005D310TF	31±25%	100	0.20	300	
GZ1005D600TF	60±25%	100	0.30	200	
GZ1005D800TF	80±25%	100	0.35	200	
GZ1005D121TF	120±25%	100	0.40	200	
GZ1005D221TF	220±25%	100	0.45	150	
GZ1005D301TF	300±25%	100	0.50	100	
GZ1005D421TF	420±25%	100	0.60	100	
GZ1005D501TF	500±25%	100	0.80	100	
GZ1005D601TF	600±25%	100	0.90	100	
GZ1005D751TF	750±25%	100	1.00	100	
GZ1005D102TF	1000±25%	100	1.20	100	
GZ1005D152TF	1500±25%	100	1.60	100	
GZ1005E800TF	80±25%	100	0.35	200	
GZ1005E121TF	120±25%	100	0.40	200	
GZ1005E241TF	240±25%	100	0.50	200	
GZ1005E601TF	600±25%	100	0.90	100	
GZ1005U100TF	0~15	100	0.05	500	
GZ1005U300TF	30±25%	100	0.20	300	
GZ1005U700TF	70±25%	100	0.30	200	
GZ1005U121TF	120±25%	100	0.40	200	
GZ1005U221TF	220±25%	100	0.50	100	
GZ1005U301TF	300±25%	100	0.60	100	
GZ1005U421TF	420±25%	100	0.80	100	
GZ1005U601TF	600±25%	100	0.90	100	
GZ1005U102TF	1000±25%	100	1.20	100	

## II. GZ1608 Series of Beads

Part Number	Impedance ( $\Omega$ )	Z Test Freq. (MHz)	DCR ( $\Omega$ ) Max.	I <sub>r</sub> (mA) Max.	Thickness (mm) [inch]
GZ1608D110TF	0~15	100	0.05	2000	0.8±0.15 [.031±.006]
GZ1608D300TF	30±25%	100	0.05	2000	
GZ1608D600TF	60±25%	100	0.10	500	
GZ1608D800TF	80±25%	100	0.15	400	
GZ1608D101TF	100±25%	100	0.20	300	
GZ1608D121TF	120±25%	100	0.20	300	
GZ1608D221TF	220±25%	100	0.30	300	
GZ1608D301TF	300±25%	100	0.35	200	

GZ1608D471TF	470±25%	100	0.45	200
GZ1608D601TF	600±25%	100	0.45	200
GZ1608D751TF	750±25%	100	0.50	200
GZ1608D102TF	1000±25%	100	0.60	200
GZ1608D152TF	1500±25%	100	0.70	150
GZ1608D182TF	1800±25%	100	0.90	100
GZ1608D202TF	2000±25%	100	1.20	100
GZ1608D222TF	2200±25%	100	1.20	100
GZ1608E800TF	80±25%	100	0.15	300
GZ1608E121TF	120±25%	100	0.20	300

Part Number	Impedance ( $\Omega$ )	Z Test Freq. (MHz)	DCR ( $\Omega$ ) Max.	I <sub>r</sub> (mA) Max.	Thickness (mm) [inch]
GZ1608E181TF	180±25%	100	0.30	300	0.8±0.15 [.031±.006]
GZ1608E301TF	300±25%	100	0.35	200	
GZ1608E601TF	600±25%	100	0.45	200	
GZ1608E102TF	1000±25%	100	0.60	200	
GZ1608E202TF	2000±25%	100	1.00	100	
GZ1608U100TF	0~15	100	0.05	2000	
GZ1608U300TF	30±25%	100	0.05	2000	
GZ1608U600TF	60±25%	100	0.10	500	
GZ1608U121TF	120±25%	100	0.20	300	
GZ1608U221TF	220±25%	100	0.30	300	
GZ1608U301TF	300±25%	100	0.35	200	
GZ1608U471TF	470±25%	100	0.40	200	
GZ1608U601TF	600±25%	100	0.50	200	
GZ1608U102TF	1000±25%	100	0.60	200	

### III. GZ2012 Series of Beads

Part Number	Impedance ( $\Omega$ )	Z Test Freq. (MHz)	DCR ( $\Omega$ ) Max.	I <sub>r</sub> (mA) Max.	Thickness (mm) [inch]
GZ2012D070TF	0~15	100	0.04	2000	0.85±0.2 [.033±.008]
GZ2012D190TF	19±25%	100	0.04	2000	
GZ2012D300TF	30±25%	100	0.05	1500	
GZ2012D800TF	80±25%	100	0.10	1000	
GZ2012D121TF	120±25%	100	0.15	800	
GZ2012D181TF	180±25%	100	0.18	700	
GZ2012D221TF	220±25%	100	0.20	600	
GZ2012D301TF	300±25%	100	0.20	500	
GZ2012D421TF	420±25%	100	0.30	500	
GZ2012D501TF	500±25%	100	0.30	500	
GZ2012D601TF	600±25%	100	0.30	500	
GZ2012D751TF	750±25%	100	0.35	500	
GZ2012D102TF	1000±25%	100	0.35	500	
GZ2012D152TF	1500±25%	100	0.40	500	
GZ2012D202TF	2000±25%	100	0.50	500	
GZ2012E800TF	80±25%	100	0.10	1000	
GZ2012E121TF	120±25%	100	0.15	800	
GZ2012E181TF	180±25%	100	0.20	600	
GZ2012E301TF	300±25%	100	0.20	500	
GZ2012E501TF	500±25%	100	0.30	500	
GZ2012E601TF	600±25%	100	0.30	500	
GZ2012E102TF	1000±25%	100	0.35	500	
GZ2012U100TF	0~15	100	0.04	2200	
GZ2012U170TF	17±25%	100	0.04	2000	
GZ2012U300TF	30±25%	100	0.05	1500	
GZ2012U470TF	47±25%	100	0.05	1500	
GZ2012U700TF	70±25%	100	0.10	1000	
GZ2012U121TF	120±25%	100	0.15	800	
GZ2012U221TF	220±25%	100	0.20	600	
GZ2012U301TF	300±25%	100	0.20	500	
GZ2012U421TF	420±25%	100	0.25	500	



GZ2012U601TF	600±25%	100	0.30	500	
GZ2012U102TF	1000±25%	100	0.40	500	

IV. GZ 3216 Series of Beads

Part Number	Impedance (Ω)	Z Test Freq. (MHz)	DCR (Ω) Max.	I <sub>r</sub> (mA) Max.	Thickness (mm) [inch]
GZ3216D000TF	0~15	100	0.03	2200	0.85±0.2 [.033±.008]
GZ3216D310TF	31±25%	100	0.05	2000	
GZ3216D600TF	60±25%	100	0.10	1000	
GZ3216D800TF	80±25%	100	0.10	1000	
GZ3216D121TF	120±25%	100	0.10	1000	
GZ3216D221TF	220±25%	100	0.20	600	
GZ3216D301TF	300±25%	100	0.20	600	
GZ3216D501TF	500±25%	100	0.30	600	
GZ3216D601TF	600±25%	100	0.30	600	
GZ3216D102TF	1000±25%	100	0.60	500	
GZ3216D122TF	1200±25%	100	0.60	300	
GZ3216U310TF	31±25%	100	0.05	2000	
GZ3216U700TF	70±25%	100	0.10	1000	
GZ3216U301TF	300±25%	100	0.20	600	
GZ3216U601TF	600±25%	100	0.30	600	

Products with other electrical characteristic can be provided upon customer's request. Please contact your local sales.

D, E, U Material Comparison

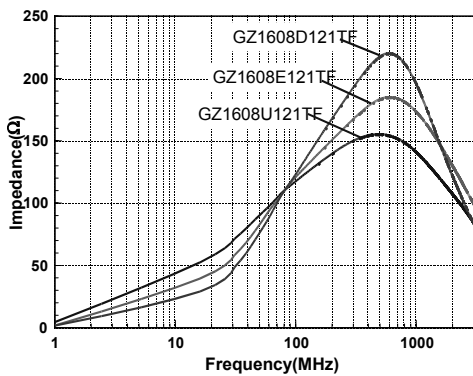

Impedance Frequency Characteristics

GZ0603 series

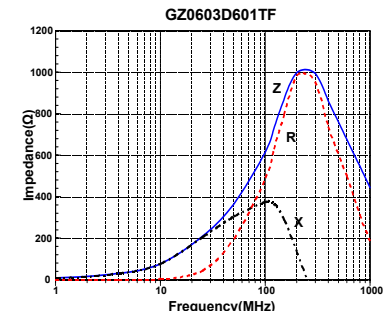
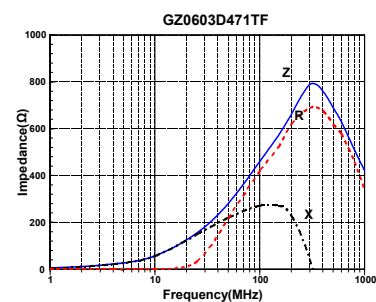
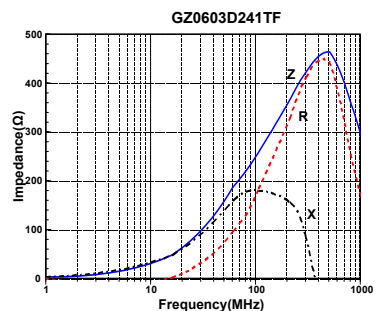
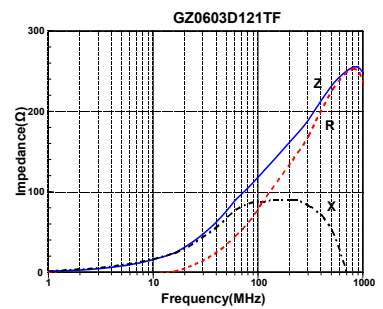
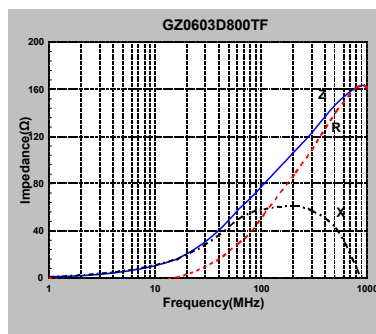
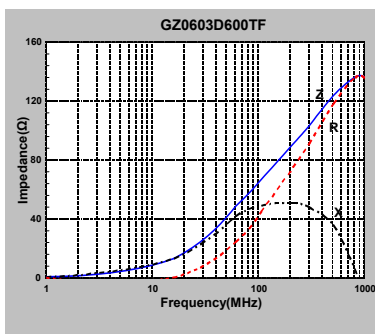

GZ1005 series

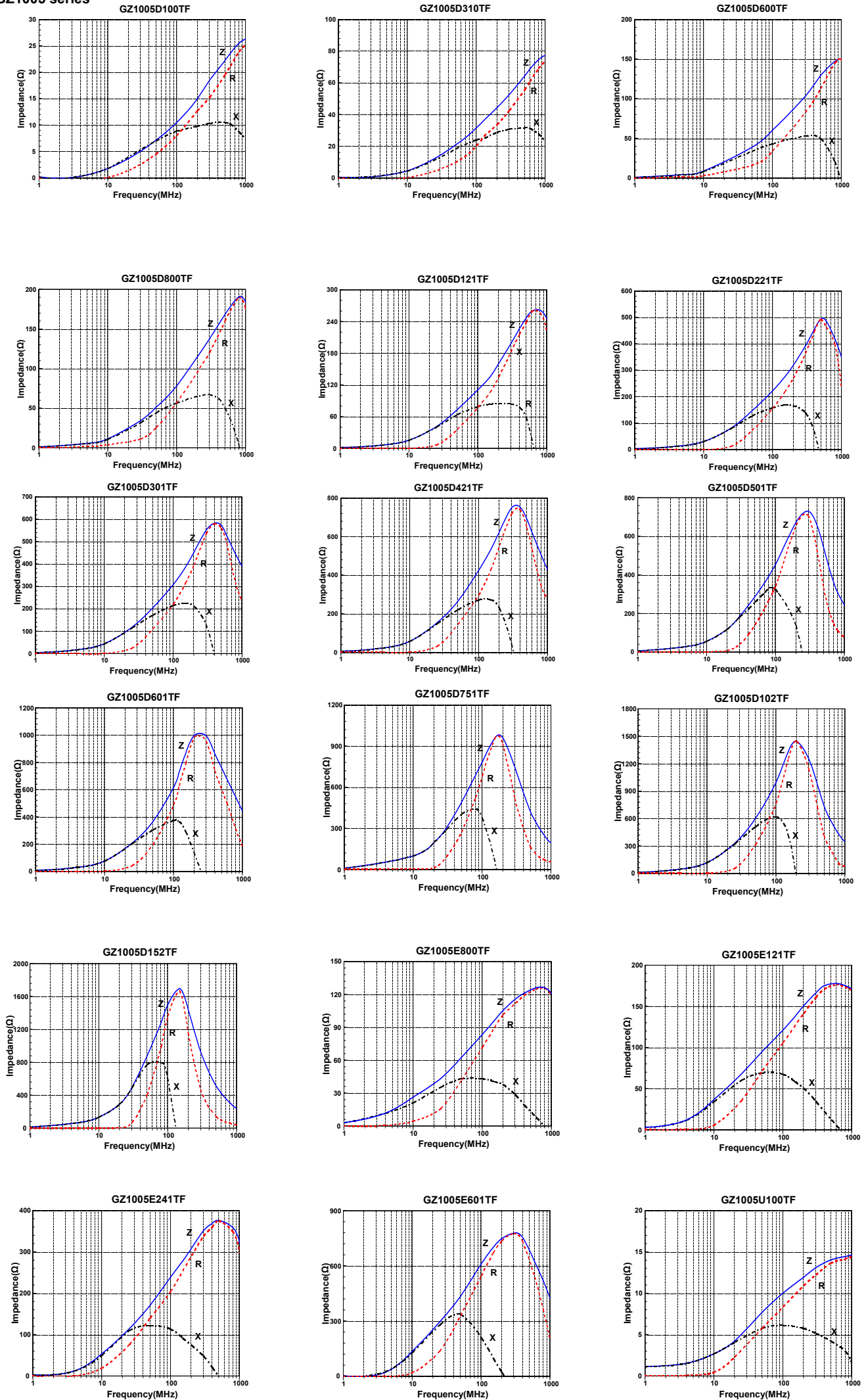





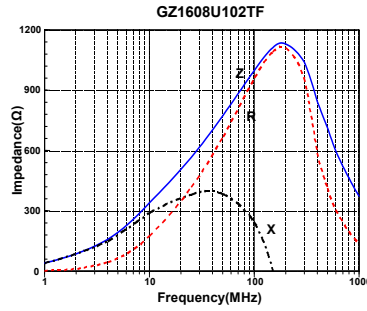
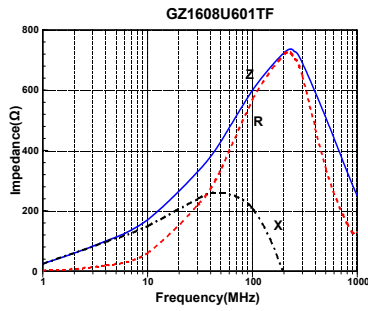
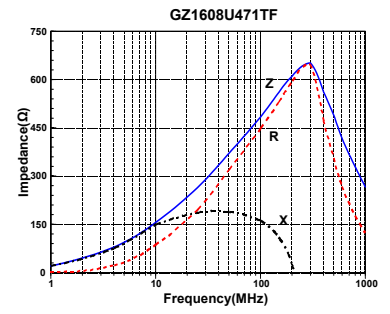
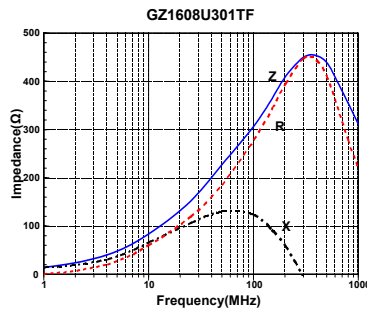
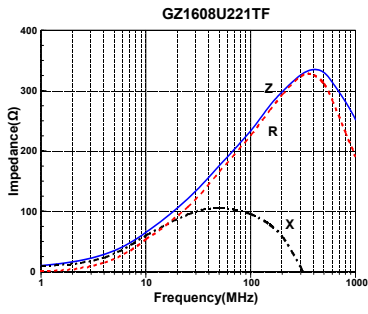

GZ2012 series

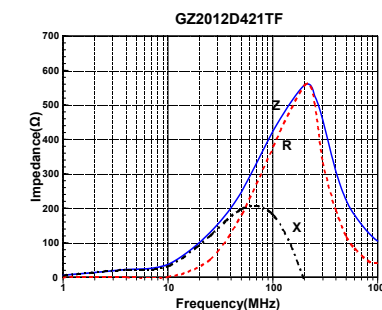
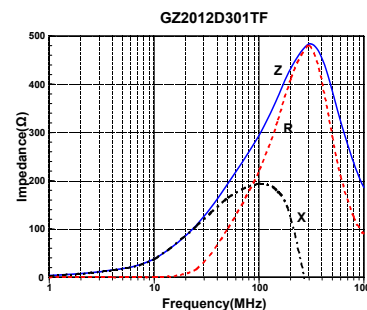
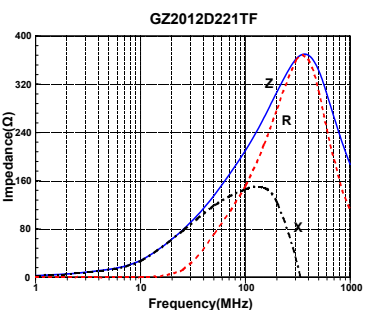
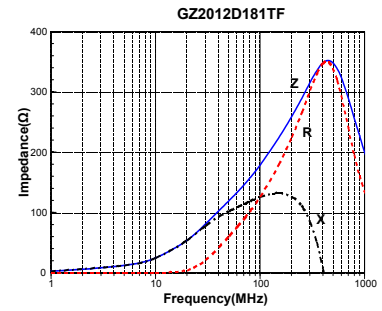
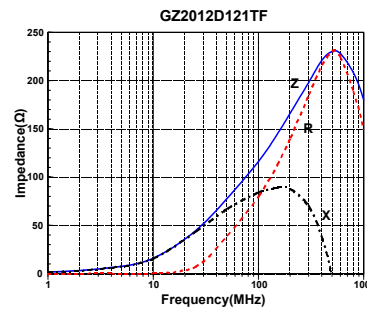
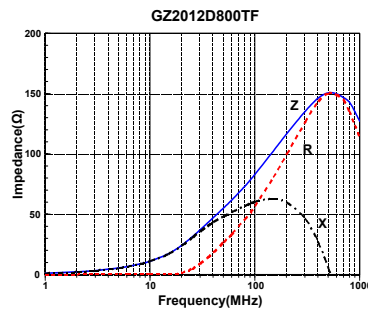
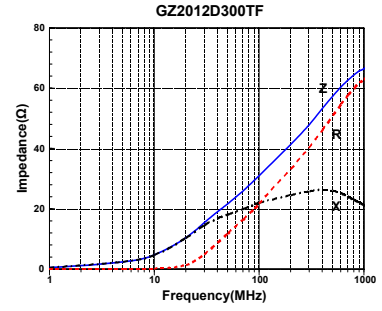
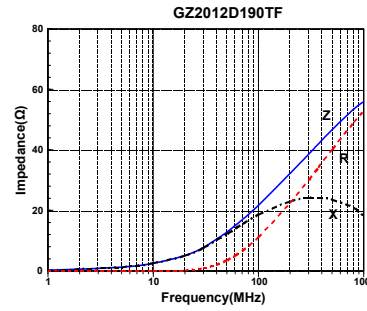
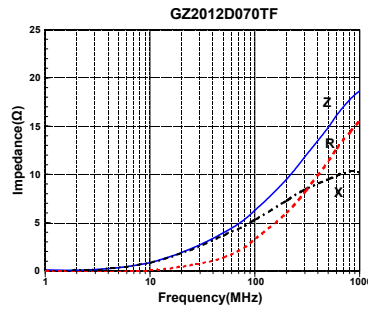



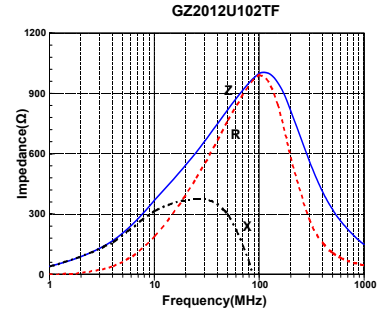
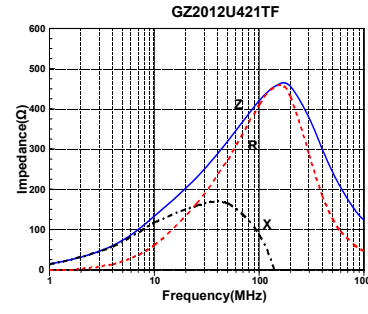
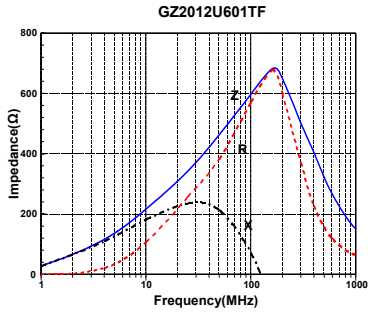
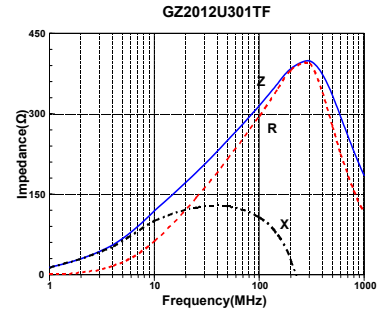
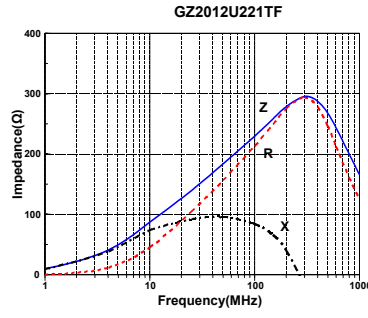
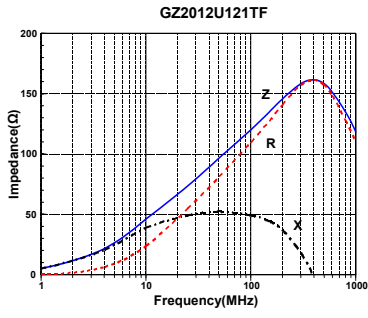

GZ3216 series

